

## TABLE OF CONTENTS

Introduction .....	1
Fitting Simulation .....	2
Pull Down Menus .....	3
Insert .....	3
Tools .....	4
Analyze .....	5
Window .....	5
Fitting Simulation Workbench .....	6
Manipulation .....	7
Recorder .....	8
Player .....	8
Bottom Toolbar .....	9
Viewing .....	9
Fitting Simulation .....	11
Creating Tracks .....	11
Compass .....	12
Color Action .....	21
Visibility Action .....	22
Sequences .....	23
Shuttles .....	28
Creating a Sequence from Explode .....	39
Modifying Tracks .....	41
Reordering Shots .....	41
Reusing Shots .....	43
Shot Time .....	45
Adding, Deleting and Modifying Shots .....	47
Advanced Tracks .....	49
Mirroring Tracks .....	50
Reversing Tracks .....	55
Joining Tracks .....	60
Generating Tracks .....	63
Clash Detection .....	64
Path Finder .....	68
Smooth .....	72
Angle Validation .....	75
Advanced Sequences .....	79
Advanced Shuttles .....	79
Gantt Chart .....	87
Generating a Replay .....	90
Generating a Video .....	91
Clash Analysis .....	92
Distance Analysis .....	99
Analysis with Sequences .....	104
Swept Volumes .....	108
Experiments .....	111

---

Other Tracks .....	117
Introduction .....	119
Kinematics .....	120
Pull Down Menus .....	121
Insert .....	121
Tools .....	123
Analyze .....	124
Window .....	124
Kinematics Workbench .....	125
Player .....	126
Bottom Toolbar .....	127
Viewing .....	127
Kinematics .....	129
Joints .....	129
Revolute - Null Offset .....	130
Revolute - Centered .....	136
Prismatic .....	139
Cylindrical - Angle and Length .....	142
Cylindrical - Length .....	145
Cylindrical - Angle .....	147
Screw .....	149
Spherical .....	152
Planar .....	154
Rigid .....	156
Point Curve .....	158
Slide Curve .....	160
Roll Curve .....	162
Point Surface .....	165
Universal .....	168
Constant Velocity .....	173
Gear .....	176
Rack .....	180
Cable .....	183
Joints using Axis Systems .....	185
Assembly Constraints .....	189
Auto Create .....	189
Advanced .....	191
Simulations .....	197
Simulation .....	197
Compiling the simulation .....	200
Replay .....	201
Simulation player .....	202
Sequences .....	204
Generate Replay .....	207
Generate Video .....	208

---

Knowledgeware .....	210
Laws .....	210
Rules .....	214
Advanced Laws .....	218
Path Generation .....	224
Traces .....	224
Swept Volumes .....	227
Sensors .....	233
Speed and Acceleration .....	239
Clash and Distance .....	243
Joint Limits .....	249
Mechanism Dressup .....	251
Mechanism Analysis .....	255
Tracks and Simulations .....	257
Problems .....	259
Problem #1 .....	259
Problem #2 .....	260
Problem #3 .....	261
Problem #4 .....	262
Problem #5 .....	263
Problem #6 .....	264
Appendix A .....	267
Digital Mockup - DMU Fitting - DMU Fitting .....	267
Digital Mockup - DMU Fitting - DMU Manipulation .....	268

## **Introduction**

### **CATIA Version 5 Fitting Simulation**

Upon completion of this course the student should have a full understanding of the following topics:

- Creating tracks
- Editing Sequences
- Creating replays and playing them back
- Using pathfinder to determine a path
- Performing clash analysis during a fitting simulation

## **Fitting Simulation**

Fitting simulation often gets confused with kinematics because it involves motion. The main difference between a fitting simulation and a kinematic simulation is that a fitting simulation moves according to a set path without regard to constraints. A kinematic simulation moves according to defined joints which control the motion of an assembly.

The purpose of fitting simulation is to show how to assemble or disassemble an assembly. This can be useful to create training videos or just to make sure that it is possible to disassemble or assemble an assembly in the defined space. The analysis available in Assembly Design only allows you to perform a clash analysis between objects in their static state. In Fitting Simulation, you can perform clash analysis between the objects as they are being disassembled or assembled. Kinematics can perform a clash analysis as an assembly operates.

Since Fitting Simulation does not involve constraints, assembly constraints are unnecessary to perform a simulation. However, you normally would want to constrain your assembly in order to have all of the parts located correctly.

## **Introduction**

### **CATIA Version 5 Kinematics**

Upon completion of this course the student should have a full understanding of the following topics:

- Creating joints
- Creating simulations and replays
- Performing analysis on a kinematic mechanism
- Using laws to help simulate a mechanism
- Converting assembly constraints to joints

## Kinematics

The first item that needs to be understood is what is kinematics. Kinematics involves an assembly of parts that are connected together by a series of joints, referred to as a mechanism. These joints define how an assembly can perform motion. When one of the joints move it causes the assembly to move. Kinematics does not involve any type of finite element analysis which means there are no associated loads or weights with the parts. You are simply moving the assembly through some range of motion as defined by the joints.

Sometimes kinematics gets confused with animation as well. Although kinematics does perform some actions similar to animation, it is a very limited. Kinematics is meant to show the range of motion of a mechanical mechanism. Basically, it will show how the movement of one joint affects all of the other joints defined in the mechanism.

The second item that needs to be understood are degrees of freedom. Every part has six degrees of freedom. It can move in three directions and it can also rotate about those three directions. In order for an assembly to be used in kinematics it must have at least one degree of freedom. The remaining degrees of freedom are controlled with commands. This is what allows the motion of the mechanism to be defined.

The hardest part about kinematics is figuring out what joints need to be defined on an assembly in order for it to operate correctly. The actual definition of the joints is pretty easy. Kinematics requires you to think a little differently without letting finite element analysis and animation to confuse the situation.

Kinematics is used to check for clearances and interferences among moving parts, and analyze the velocities of parts as well. In addition, laws can be applied to the mechanism to force the parts to accelerate.

## Simulations

Up until now you have been simulating your mechanisms using the simulation with commands icon. You can also create a simulation that can be used to generate a replay or a movie file for external use. The simulation can be used in conjunction with sequences that will allow you to put multiple simulations together and vary their duration.

### Simulation

This will allow you to create a simulation that can be used to make a replay or movie file. In addition, simulations can be put together in a sequence.

**Open the Simulation - Replay document located in the *Simulation* directory.** A simple cam mechanism appears. The mechanism is already constrained with an angle command that drives the assembly. Instead of using the simulation with commands icon you are going to create a simulation.

**Select the Simulation icon.**  A *Select* window appears. This will show all of the available simulation objects in your document.

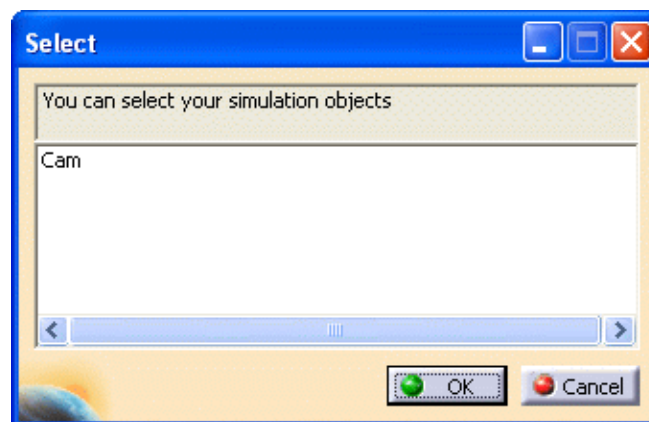

**Select the *Cam* object from the window and select *OK*.** Two windows appear. One of them is the *Kinematics Simulation* window which is similar to the window that appears with the simulation with commands icon.

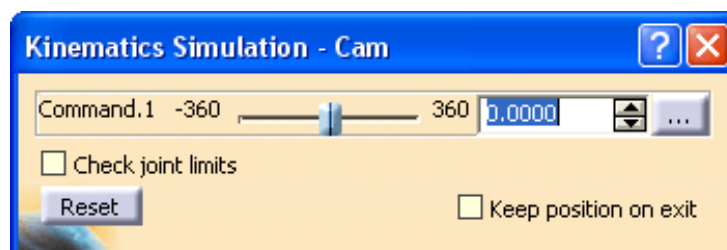



*Check Joint Limits* Checks to see if any joint limits are being reached

*Keep position on exit* The current position of your mechanism will remain when exiting the simulation. Otherwise it will reset to its original position.

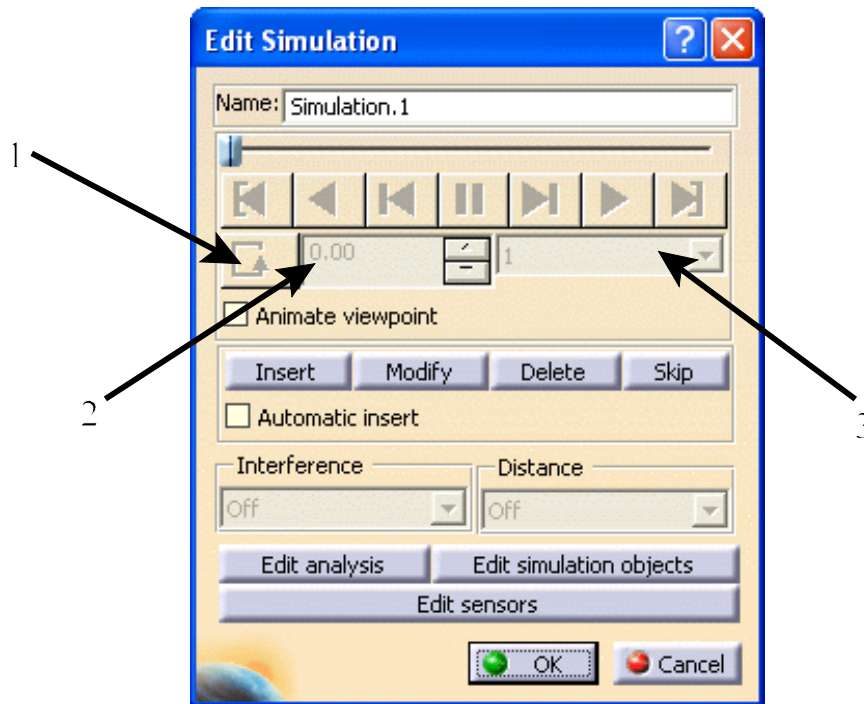
The second window is the *Edit Simulation* window.



- Name* Defines a name for the simulation. Each simulation should be given a unique and descriptive name for future reference.
- Arrow 1 The loop mode icon. Selecting this icon will change the loop mode between single loop , forward and reverse , or continuous forward .
- Arrow 2 The time step indicator. Each motion placed in the simulation indicates a time step and is displayed in the box.
- Arrow 3 The replay interpolation step. In general, it controls the speed of the replay.
- Animate viewpoint* Allows the viewpoint position to be recorded with the simulation. This would be useful if a certain area needs special attention while a component is being removed.
- Insert, Modify, Delete, Skip* Allows you to insert steps manually, modify the position at a desired step, delete a step or skip over a step during replay
- Automatic insert* Allows the positions to be automatically inserted
- Edit analysis* Allows you to add or remove various analyses to your simulation
- Edit simulation objects* Allows you to add additional objects that you want to be part of the simulation
- Edit sensors* Allows you to turn on sensors to be observed

**Change the Name to be Cam mechanism.** You have to be careful when inserting steps if you want a uniform speed. The best way to insert steps at a uniform speed is to change the command value using the step arrows.

**Select the Browse icon in the *Kinematics Simulation* window and change the *Spin box increments* to 5.0 and select *OK*.**  You are going to insert a step into the simulation every 5 degrees.

**Select the *Automatic insert* option in the *Edit Simulation* window.** This will insert a step every time you change the command value.

**In the *Kinematics Simulation* window press and hold the first mouse button while on the up arrow of the command value box.** This will change the command value in 5 degree increments until it reaches 360. There should be 72 steps in the simulation.



**Select *OK* in the *Edit Simulation* window.** Both windows close. You should see a *Simulation* branch under the *Applications* branch that contains the simulation.





**Double select on the *Cam mechanism* simulation.** The windows reappear.

**Select the *Jump to Start* icon.**  The simulation returns to the beginning.

**Select the *Play Forward* icon.**  The simulation plays forward.

**Change the replay step to 0.2 and change the *Loop Mode* to *Continuous Forward*.** 

**Select the *Play Forward* icon.**  Notice that the simulation runs fairly slow and it will continue to run until you select pause.

**Select the *Pause* icon and select *OK*.**  The simulation stops and the windows close. Notice that the assembly returned to its original position since you did not turn on the *Keep position on exit* option. You are going to create a replay out of this simulation.

## Compiling the simulation

After a simulation is created, you can generate a replay or a movie file by compiling the simulation. This will create an external file that can be viewed without CATIA or it can create an internal replay to be used by other users.

**Select the Compile Simulation icon.**  A *Compile Simulation* window appears. The icon is located under the Simulation icon.

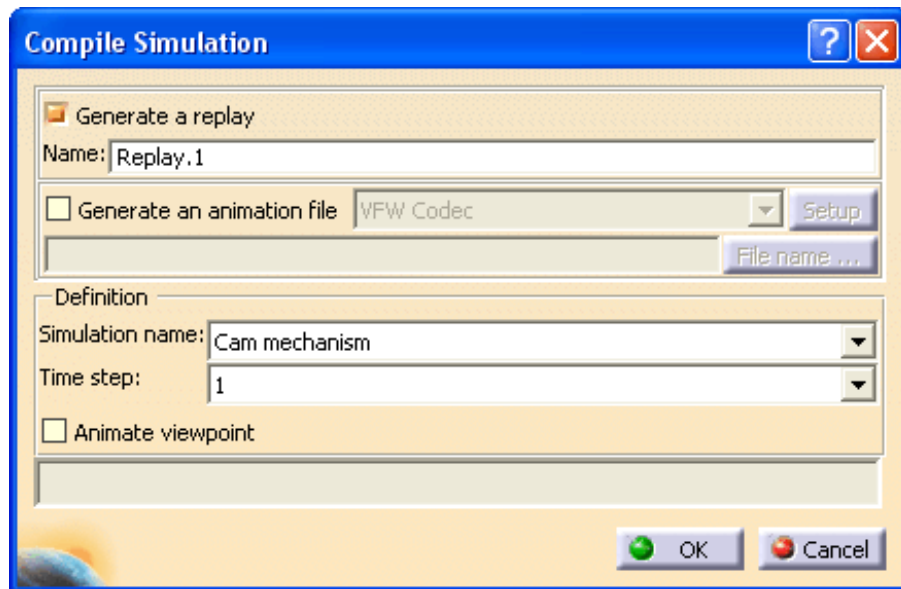

*Generate a replay* This will compile the simulation into a replay. The replay can only be viewed from within CATIA V5.

*Name* Defines a name for the replay

*Generate an animation file* Compiles the simulation into one of three file types

*Definition* Allows you to change what simulation will be compiled, the time step that it will be compiled at (same as the replay interpolation setting from the *Edit Simulation* window) and if the viewpoint is going to be compiled into the animation or replay

**Turn on the *Generate a replay* option, change the *Name* to Cam, change the *Time step* to 0.2 and select *OK*.** The replay is generated and a *Replay* branch appears under the *Applications* branch. This may take a couple of seconds to compute all of the motion.

## Replay

The replay option allows you to play a replay. This is an easy way to view an internal replay.

**Select the Replay icon.**  A *Replay* window appears. This will allow you to play your replay. The icon is located under the Simulation or Compile Simulation icon. You can also get to this window by double selecting on the replay itself.

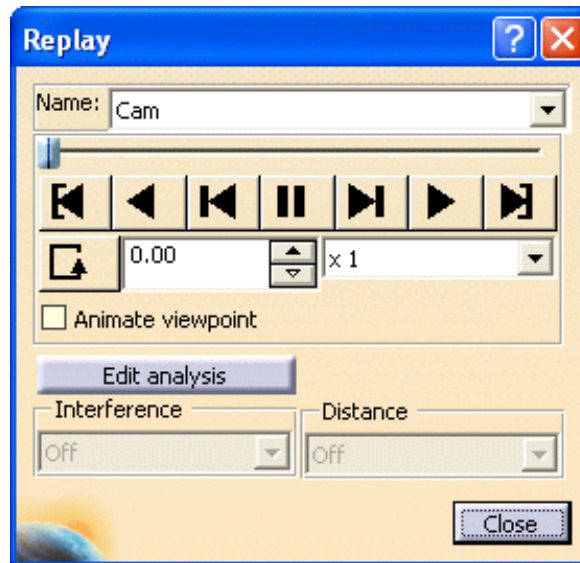

Most of the icons are the same as on the *Edit Simulation* window. The one exception is the replay time step interpolation list is now a replay speed. If the simulation was compiled at too slow a speed, it can be sped up using this dialog.

**Select the Play Forward icon.**  Notice that the replay is much smoother than when you played the simulation. This is because all of the calculations have already been performed and this is simply a video playback.

**Change the Loop Mode to Continuous Forward and change the replay speed to be x2.**

 This will play the replay over and over again creating a constant moving cam.

**Select the Play Forward icon.**  The cam mechanism continues to run over and over again.



**Select the *Close* button.** The window closes and the cam returns to its original position.

## Simulation player

The simulation player is an alternative to using the replay option. You can play any item that has motion defined. In other words, you can use this player to play a simulation or a replay. In addition, the player's speed is adjusted using a time variable. This can be important if you are using simulations with laws that are set up using time. The player can also be slowed down or sped up as opposed to the replay option which could only speed up the replay.

Select the **Simulation Player icon** and select the **Cam replay**.  A *Player* window appears. This will determine which item will be played.



*Change loop mode* Similar to the replay window you can have your item play either one time forward , continuous loop , or forward and backward .

*Simulation line* The slider can be slid along the line to various locations automatically moving your item to that parameter value. 

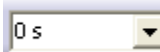
*Parameter value* Shows the current value of the parameter 

*Player commands* These act very similar to the commands available in the other windows.



Allows you to modify the parameters of the player

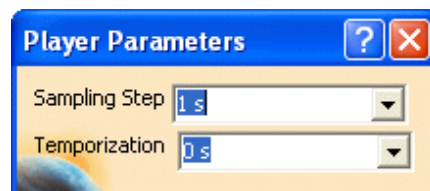



*Sampling Step* Defines how fast or slow the player will play the item

*Temporization* Defines how long the player will pause after each step before continuing

Select the **Parameters icon**.  The *Player Parameters* window appears.

Change the **Sampling Step** to **1.0s** and the **Temporization** to **0.0s** and select the **Play Forward icon**.  The replay plays quite fast.

**Change the Loop Mode to Continuous Loop.** 

**Change the *Sampling Step* to 0.5s and select the Play Forward icon.**  The replay plays continuously.

**Select the Stop icon.**  The replay stops playing.

**Change the *Temporization* to 0.2s and select the Play Forward icon.**  Notice that the replay is playing much slower since it pauses 0.2s each time it takes a step. The motion will be jerky.

**Close the player.** You can do this by selecting on the *X* in the top right corner of the *Player* window or by selecting the icon again. The window closes and the assembly returns to its initial position.

## Sequences

Sequences allow you to put together a sequence of actions. These actions can be assigned a duration which determines how fast an action occurs. This allows you to have multiple actions occur at the same time if desired. This exercise will have you create a sequence using the one simulation that you created.

**Select the Edit Sequence icon.**  The *Edit Sequence* window appears along with the *Player* window. The icon is located under the simulation player icon.

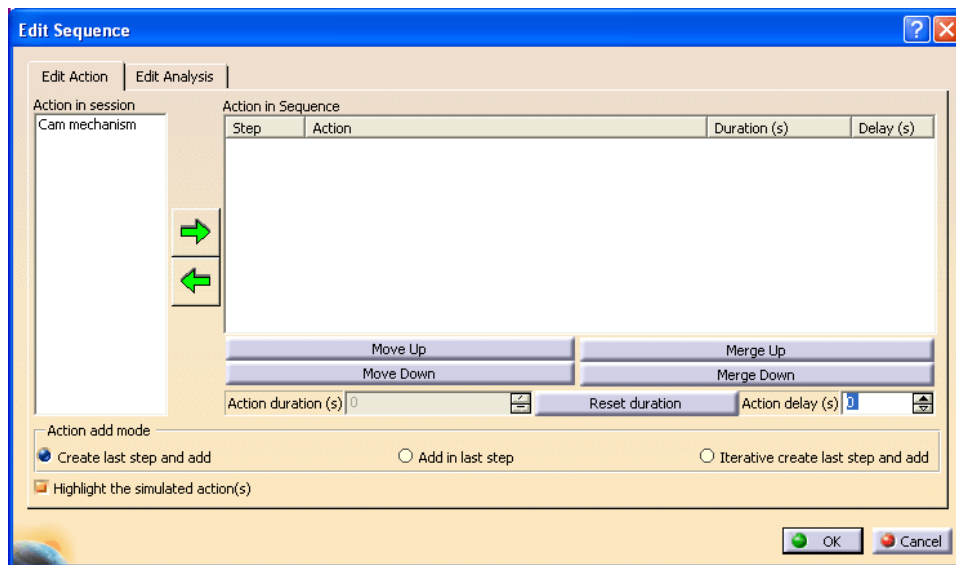

- Action in session*      These are all the actions that can be added to the sequence.
- Action in Sequence*      This is where your sequence will appear. By selecting one of the actions in the session, then selecting the right arrow, the action will be merged into the sequence.
- Move Up/Down*      Changes the order of the actions in the sequence
- Merge Up/Down*      Merges actions together to make them occur at the same time
- Action duration*      Defines the length of time for each action in seconds
- Reset duration*      Resets the duration to its original duration
- Action delay*      Defines how long an action will wait before beginning
- Action add mode*      Defines how the next action gets added to the sequence
- Create last step and add*      Adds the next action after the last action (Consecutive)
- Add in last step*      Adds the next action with the last action (Simultaneous)
- Iterative create last step...*      Adds a group of actions in consecutive order

Select the *Cam mechanism* simulation from the window and select the green arrow pointing to the right.  The simulation is put into the sequence. The default duration is 72s.

Insert the *Cam mechanism* simulation again. You can do this in the same manner as you did previously.

Insert the *Cam mechanism* simulation three more times. This will give you five full turns of the mechanism.

Select **OK**. The sequence is created and you will have a *Sequences* branch under the *Applications* branch.

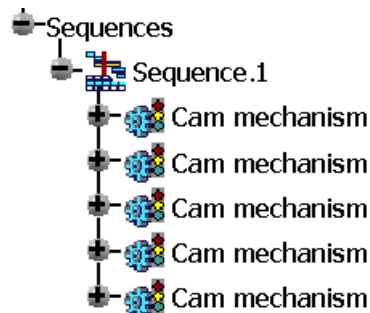

Select the **Edit Sequence** icon again.  The *Edit Sequence* window appears. This time you have *Sequence.1* as an available action as well as the *Cam mechanism* simulation. You are going to create a sequence that has five revolutions of the mechanism but at twice the speed.

Insert the *Cam mechanism* simulation and change the *Action duration* to 36. The duration will change in the window after you select another option.

Insert the *Cam mechanism* simulation again and change the *Action duration* to 36.

Insert the *Cam mechanism* simulation three more times making each one have a duration of 36.

Select **OK**. *Sequence.2* is created.

Create another sequence with the *Cam mechanism* simulation inserted five times with a duration of 144 each. You should have three sequences created. You are going to create one sequence that contains all three sequences.

Select the **Edit Sequence** icon again.  The *Edit Sequence* window appears. The three sequences should appear as available actions.

Turn on the *Iterative create last step and add* option, select all three of the sequences and select the green arrow pointing to the right.  The three sequences are inserted consecutively. You will need to use the Ctrl or Shift key in order to select all three at once.

The sequence should look similar to the one shown below.

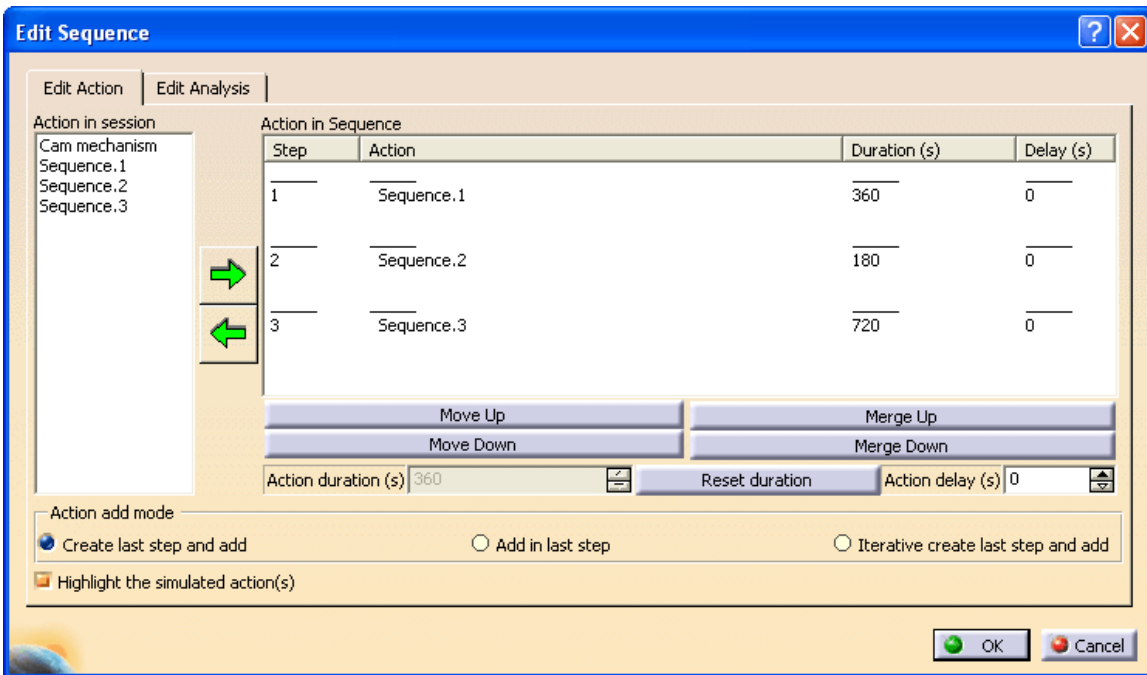

Select the Parameters icon in the *Player* window and change the *Sampling Step* to 3.0s and the *Temporization* to 0.0s.  This will play the sequence at a rate of 3s per step.

Move the windows so that you can see the mechanism work and select the Play Forward icon in the *Player* window.  Notice that the cam turns faster after five revolutions and then slows down after another five revolutions.

Select *OK* in the *Edit Sequence* window. All of the windows close. *Sequence.4* appears in the specification tree as shown below.

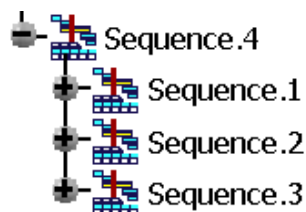

You are going to generate a replay from the sequence, however, you cannot use the compile simulation icon to do this. The compile simulation icon only works with simulations. You are going to have to use a different option found in the pull down menus.

## Generate Replay

The generate replay option is found in the pull down menus and is used to generate a replay out of any item that has motion. It can be used with a simulation or sequence unlike the compile simulation option which only works with a simulation. The generate replay option will not generate a video or movie file. If you want to do that, you need to use a different option.

**Select pull down menu *Tools, Simulation, Generate Replay*.** A *Player* window appears and it is waiting for you tell it which item you want to use to create the replay.

**Select *Sequence.4* from the specification tree.** The *Replay Generation* window appears.

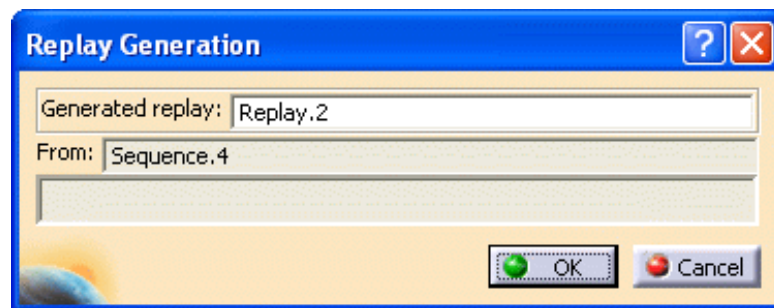

**Select *OK*.** The replay is generated. This may take a couple of minutes since it has to run through the entire sequence to generate the replay.

**Select the *Simulation Player* icon and then *Replay.2* from the specification tree.**  The *Player* window appears. The icon may be located under the sequence icon. This will allow you to play the replay.

**Change the *Sampling Step* to 2.0s under the *Parameters* icon.** 

**Select the *Play Forward* icon.**  Notice that the replay plays faster than the sequence due to the calculations that took place when generating the replay.

**Close the *Player* window.** If you want to generate a video or movie file you need to use another option.

## Generate Video

The generate video option will allow you to create a video or movie file from any item that has motion. This is similar to creating a video file using the compile simulation icon but it works with other items besides simulations.

Select pull down menu **Tools, Simulation, Generate Video**. A *Player* window appears and it is waiting for you tell it which item you want to use to create the video or movie file.

Select **Replay.2** from the specification tree. You could have selected the sequence if you preferred. The *Video Generation* window appears. You have the same options of creating an video file or a series of images.

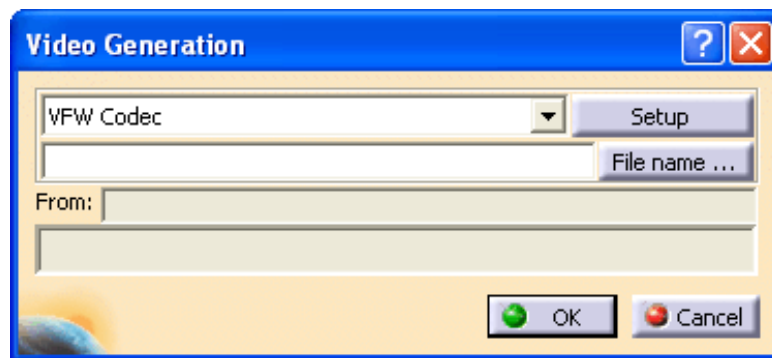

Change the *Sampling Step* to 5.0s under the Parameters icon in the *Player* window.



Select the *Setup* button in the *Video Generation* window. The *Choose Compressor* window appears. You are going to change the compressor to make the video file a reasonable size.

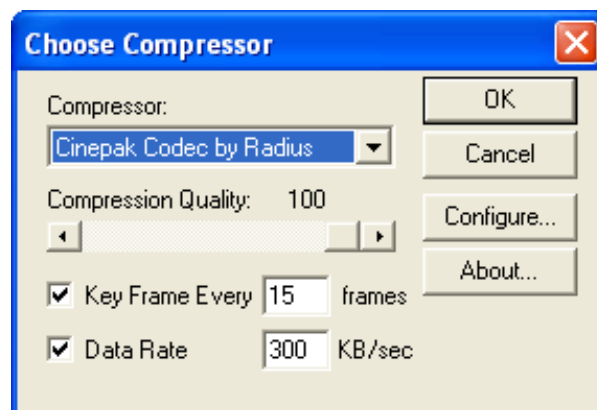

Change the *Compressor* to *Cinepak Codec by Radius* and drag the *Compression Quality* to 100.

Select *OK* in the *Choose Compressor* window. The window closes.

**Select the *File name...* button in the *Video Generation* window.** The *File Selection* window appears.

**Go to your area and make the *File name* Cam and select *Save*.** The path and file name appear in the window.

**Turn off the display of your specification tree and select *OK*.** Press F3 to turn off the specification tree or you can select pull down menu *View, Specifications*. The video file is being generated. This will take quite a while due to the size of the file. When it is finished all of the windows will close.

**Turn your specification tree back on.**

**Minimize CATIA and go to your area and play the *Cam* video file.** You can play it by double selecting on it. As you can see, the file can be viewed outside of CATIA.

**Close the media player and go back to CATIA.** You have to be careful generating video files because they can become very big files.

**Save and close your document.** This exercise introduced how to use the simulation tools. Later in the course, you will use these tools along with other options.

## Path Generation

There are a couple of methods to generate the path of an object. You can either create a trace or a swept volume. A trace will create a wireframe path whereas the swept volume will create the actual volume of the path.

### Traces

Traces allow you to define a point, line or any combination of those elements and it will create wireframe geometry showing the path those elements take during simulation. The trace will only work if you have a replay created or if the mechanism can be simulated with laws.

**Open the Trace - Swept Volume document located in the *Path Generation* directory.** You will see a mechanism that you worked with earlier. There already is a simulation and replay generated for this mechanism, but, there are no laws associated with the mechanism.

Select the Trace icon.  The *Trace* window appears.

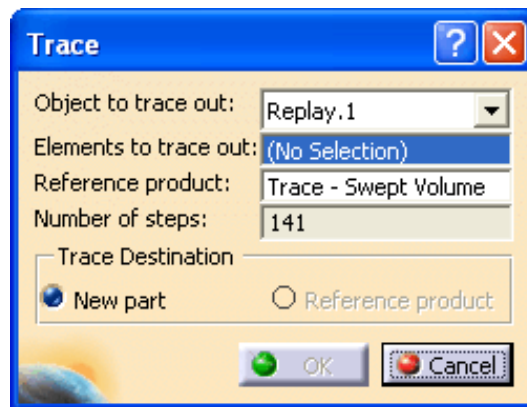

*Object to trace out* Defines the replay or mechanism that will be used to perform the trace. In order for a mechanism to be available it has to have a law.

*Elements to trace out* Defines the elements that will be traced, either a point, line or a combination of those

*Reference Product* Defines which part or product will contain the trace. If a product is chosen then a *New Part* will be created within the product that contains the trace.

*Number of steps* Shows how many steps will be involved in the object you chose to trace. You cannot change the number of steps within the *Trace* window, it is determined by the object. If you want the number of steps to be different you will have to change them within the object itself.

*Trace Destination* You can specify whether you want the trace to go into a *New Part* or the *Reference Product*. If the *Reference Product* is a product then only the *New Part* option is available.

**Select the point at the end of the pencil that touches the flat block as shown below.** This defines the element that you are going to trace. The only object that you can use to create the trace is *Replay.1*.

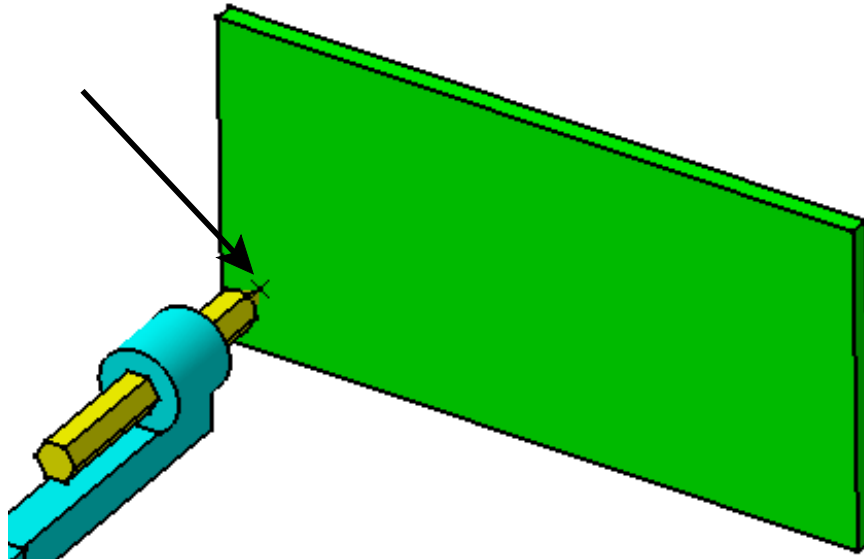

**Select in the *Reference Product* box and select the *Block*.** You can select it either in the specification tree or from the graphic area.

**Make sure the *Trace Destination* is set to *Reference Product* and select *OK*.** The trace is created and it appears on the block. You are going to open the block to take a better look at it.

**In the specification tree, press the third mouse button while on the *Block*, select *Block.1 object* and *Open in New Window*.** The part is opened in a new window.

**Hide all of the points.** You can do this by using pull down menu *Tools, Hide, All Points*. You should see a spline that was generated from the trace.

**Save and close this document.** You should see the mechanism with the spline on the block.

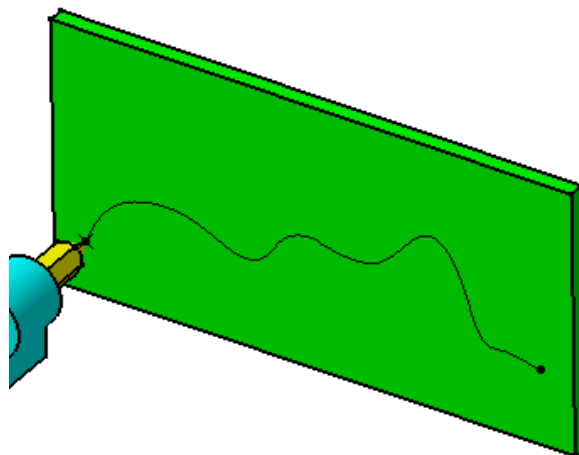

Select the Trace icon again.  The *Trace* window appears.

Select the point at the end of the pencil that touches the contoured base. This time you are going to use the main product as the *Reference Product*.

Notice that the *Destination of the trace is New Part* and select *OK*. A new part window appears with the trace.

Hide all of the points and planes. You can do this in the same manner as you did earlier.

Save and close this document. You should see your mechanism again.

Insert the Trace1 document into the assembly. The trace appears in the assembly.

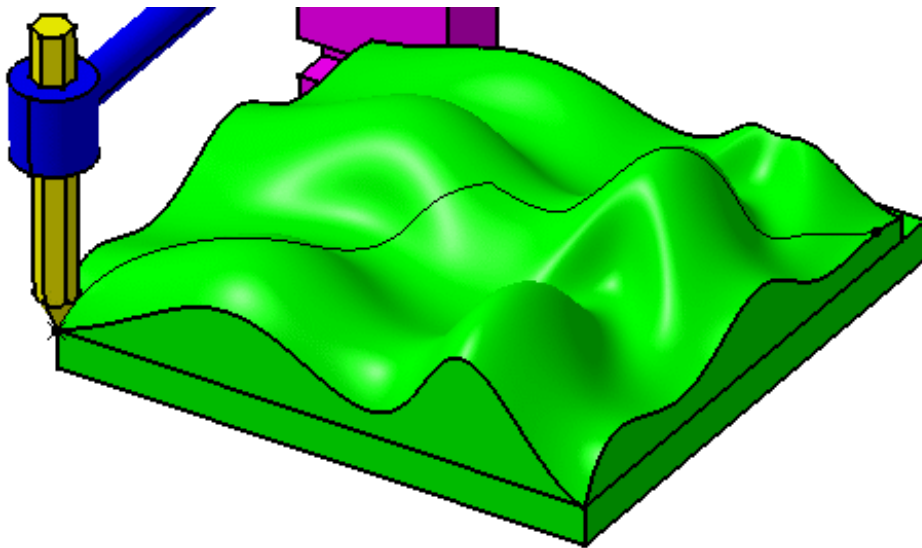

Save your document. You are going to create a swept volume using the dark blue part.

## Swept Volumes

Swept volumes are used to create volumes that represent the total space an object or objects use when in motion. These can be saved as cgr files which are “light” models and then inserted into assemblies to check for interferences. Just like the trace, the swept volume will only work with a replay or a mechanism with laws.

Select the Swept Volume icon.  The *Swept Volume* window appears.

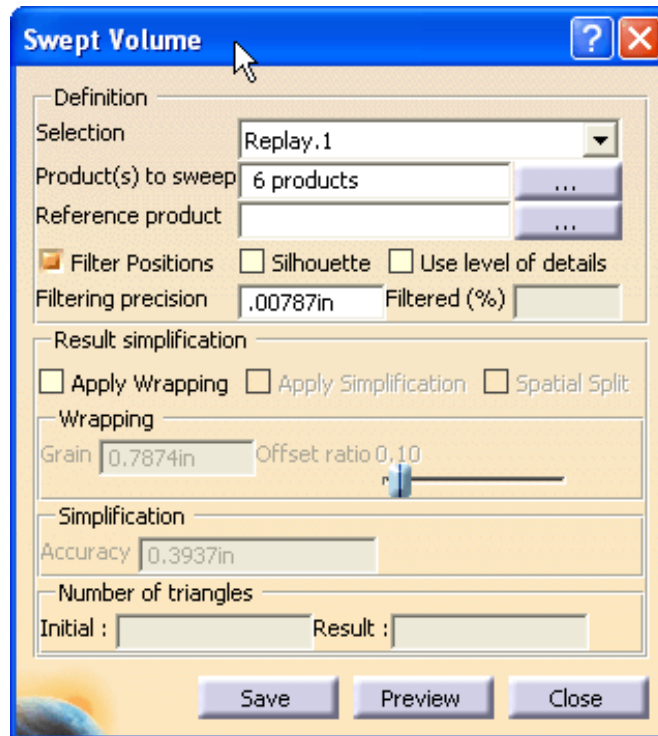

<i>Selection</i>	Defines the item that will be used to perform the motion
<i>Product(s) to sweep</i>	Defines the objects that will be used to create the swept volume
<i>Reference product</i>	Allows you to define a moving product that you want the product(s) to sweep to reference
<i>Filter Positions</i>	Reduces the number of positions that will be kept in the swept volume
<i>Filtering precision</i>	Defines the maximum distance allowed between the filtered result and the non-filtered result
<i>Result simplification</i>	Simplifies the resulting volume by using <i>Wrapping</i> and <i>Simplification</i> . These are only available if you have the DMU Optimizer license.
<i>Number of triangles</i>	Shows the number of triangles used to create the swept volume. The <i>Result</i> value is how many triangles there are after optimizing with wrapping or simplification.

Select the **Browse** icon next to the *Product(s) to sweep*.  The *Product Multiselection* window appears.

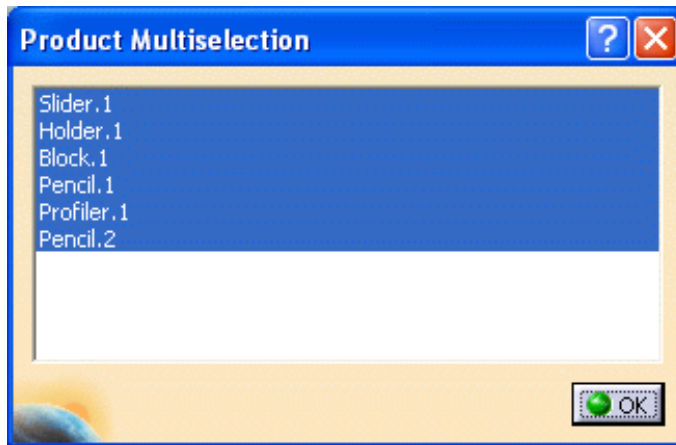

Select the *Profiler.1* object from the window and select *OK*. This will be the product that you are going to sweep. By default the *Filter Positions* option is on.

Turn off the *Filter Positions* option and select *Preview*. A *Preview* window appears showing you the result. Notice the number of triangles.

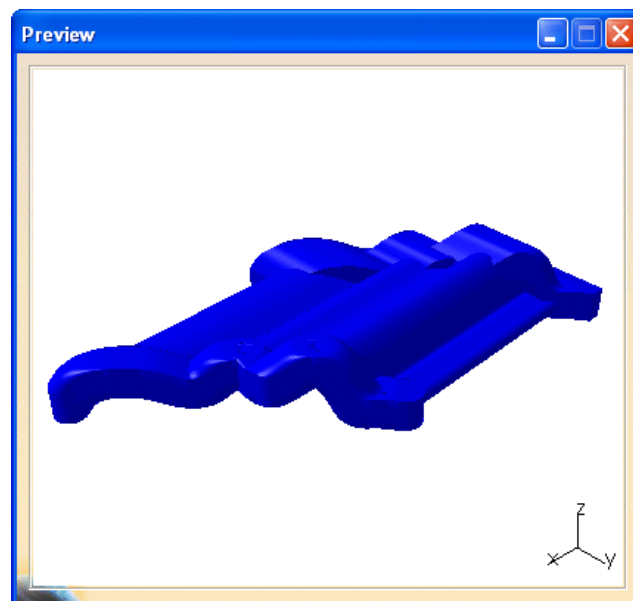

Turn on the *Filter Positions* with a *Filtering precision* of **0.005** and select *Preview*. The preview does not look that much different but it is comprised of fewer triangles and it filtered a majority of the positions.

Change the *Filtering precision* to **0.1** and select *Preview*. You can see how the volume becomes less smooth as you increase the precision. This filtered more of the positions and is using even fewer triangles.

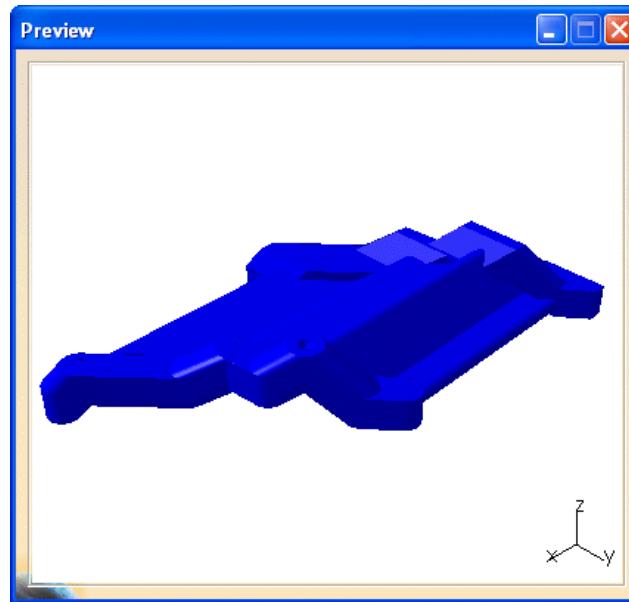

Change the *Filtering precision* back to **0.005**, turn on the *Apply Wrapping* option using the default values and select *Preview*. This is like taking a plastic sheet and wrapping the volume with it. Notice that the wrapping reduced the number of triangles.

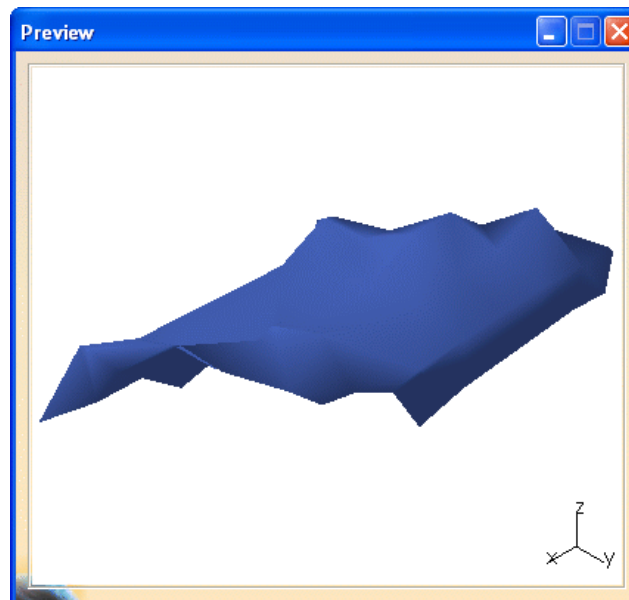

Turn on the *Apply Simplification* option using the default values and select *Preview*. The number of triangles is reduced.

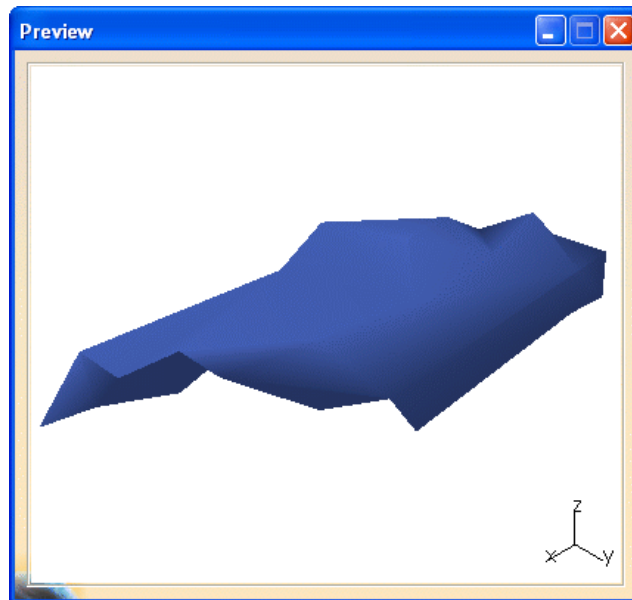

Turn off the *Apply Simplification* and *Apply Wrapping* options and select *Preview*. You are going to define a reference product for this swept volume.

Select the **Browse** icon next to the *Reference product*.  The *Reference Product Selection* window appears.

Select the *Slider.1* object from the window and select *OK*. This will show the motion of the profiler with respect to the slider.

Select *Preview*. The only motion is back and forth since the slider moves sideways with the profiler.

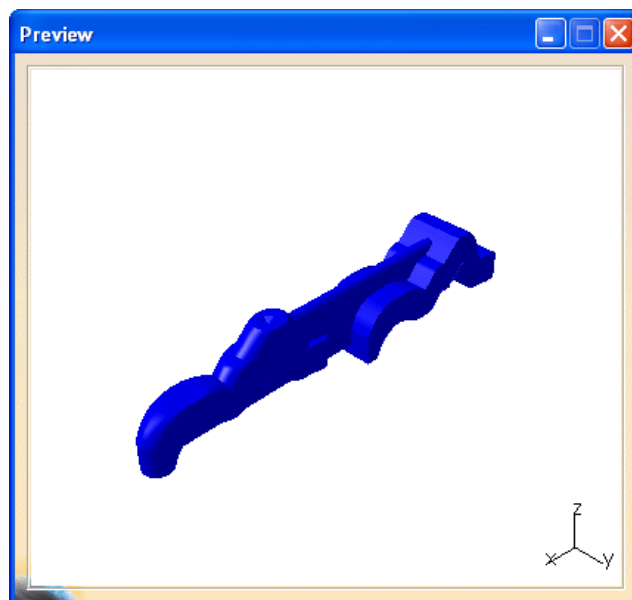

Select the **Browse** icon next to the *Reference* product, select the *Slider.1* object from the window and select **OK**.  This removes the object so that there is not a reference product defined.

Select the **Browse** icon next to the *Product(s) to sweep*, select the *Slider.1*, *Holder.1*, *Pencil.1*, *Profiler.1* and *Pencil.2* objects and select **OK**.  You will probably have to use the Ctrl key to select all of them. There should be 5 *products* in the *Product(s) to sweep* box.

Select **Preview**. All of the objects are used for the swept volume.

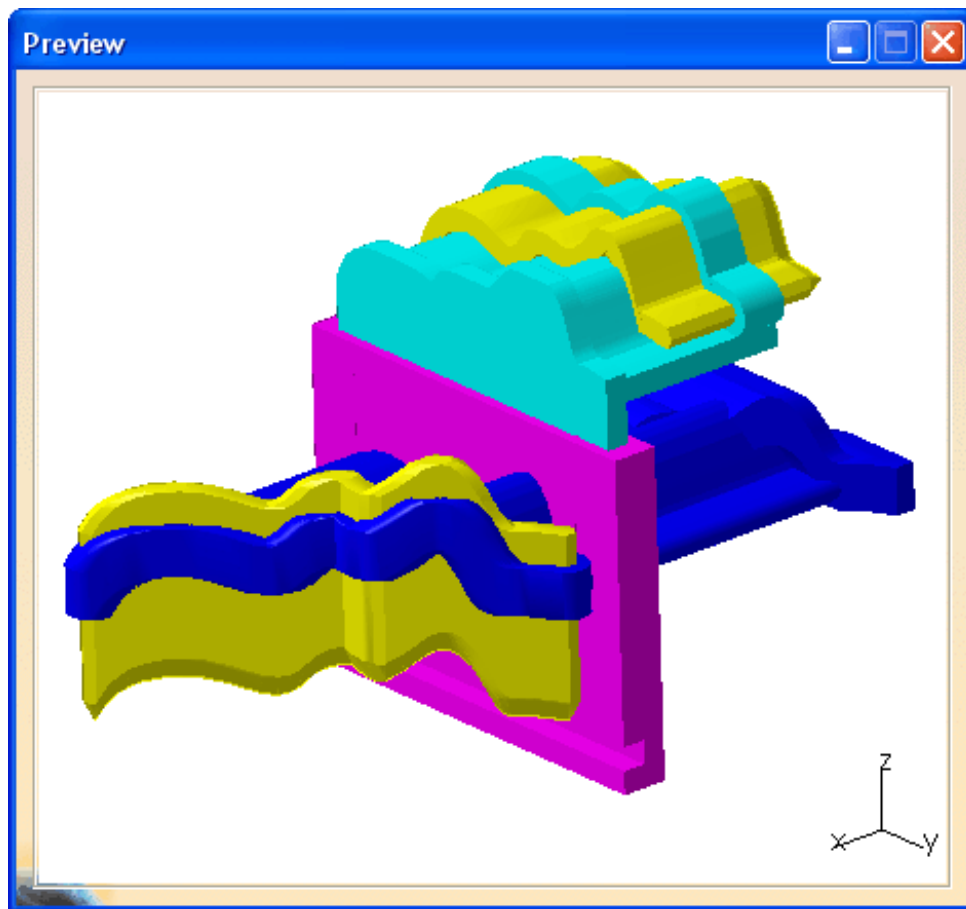

Select **Save** in the window. A *Save As* window appears. You can save the swept volume as a cgr, wrl, model or stl file. A cgr is a computer graphic representation, a wrl is a VRML file for web viewing, a model file is a V4 file type and an stl is for stereolithography.

**Save each swept volume in your area using the default name as cgr files.** You are going to insert these files into your assembly.

Select **Close**. The windows close.

**Insert the five swept volumes into this assembly.** Your assembly should appear similar to the one shown below.

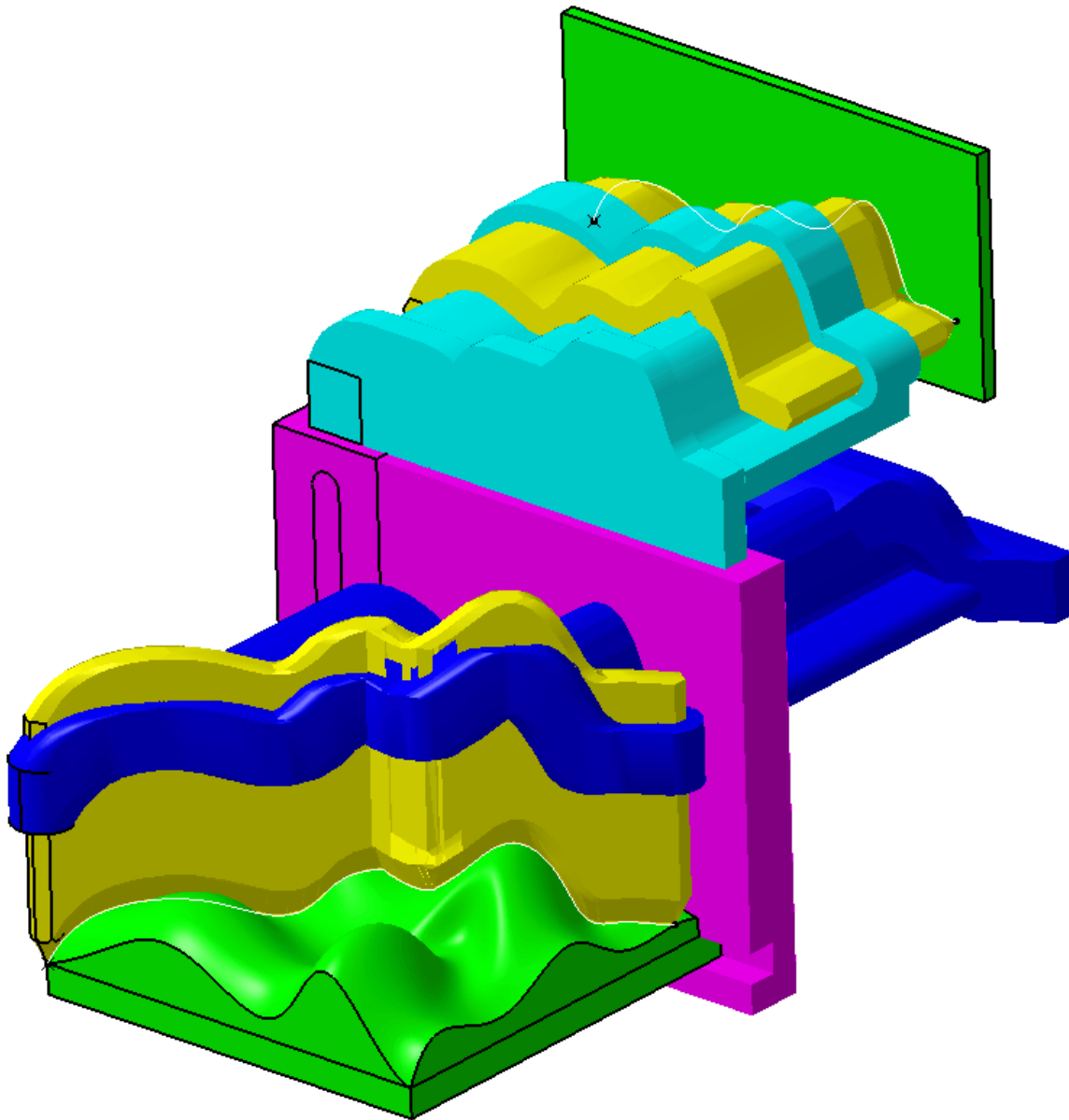

**Save and close your document.**